

# USER'S MANUAL

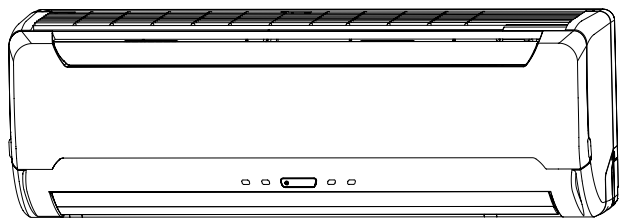

## AIR-CONDITIONER

ENGLISH



SRK20HG-S  
SRK28HG-S  
SRK40HG-S

MANUEL DE L'UTILISATEUR

CLIMATISEUR

FRANÇAIS

ANWENDERHANDBUCH

KLIMAGERÄT

DEUTSCH

ISTRUZIONI PER L'USO

CONDIZIONATORE D'ARIA

ITALIANO

MANUAL DEL PROPIETARIO

ACONDICIONADOR DE AIRE

ESPAÑOL

GEBRUIKERSHANDLEIDING

AIRCONDITIONING

NEDERLANDS

MANUAL DO UTILIZADOR

APARELHO DE AR CONDICIONADO

PORTUGUÊS

ΟΔΗΓΙΕΣ ΧΡΗΣΗΣ

ΚΛΙΜΑΤΙΣΤΙΚΟ

ΕΛΛΗΝΙΚΑ

РУКОВОДСТВО ПО ЭКСПЛУАТАЦИИ

КОНДИЦИОНЕР ВОЗДУХА

РУССКИЙ

KULLANIM KILAVUZU

SPLIT KLİMA

TÜRKÇE



Большая библиотека технической документации  
<http://splitoff.ru/tehn-doc.html>  
каталоги, инструкции, сервисные мануалы, схемы.

Thank you for purchasing a MITSUBISHI HEAVY INDUSTRIES, LTD. Air-Conditioner. To get the best long-lasting performance, read and follow this User's Manual carefully before using your air-conditioner. After reading, please store the Manual in a safe place and refer to it for operational questions or in the event of any irregularities.

This air-conditioner is intended for domestic use.

An alternative refrigerant (R410A) is used in this air-conditioner. When asking the dealer for service or inspection and maintenance, explain the dealer about this matter.

**ENGLISH**

## contents

---

Safety precautions.....	2
Name of each part and its function .....	4
Operation and indication section for remote control .....	5
Present time setting procedure .....	5
AUTO mode operation procedure .....	6
Temperature adjustment during AUTO .....	6
About FAN SPEED .....	6
COOL/HEAT/DRY mode operation procedure .....	7
Air-conditioner operating conditions .....	7
Characteristics of HEAT mode operation .....	7
Air flow direction adjustment procedure .....	8
SLEEP operation procedure .....	9
OFF-TIMER operation procedure .....	9
ON-TIMER operation procedure.....	10
SLEEP operation + ON-TIMER operation procedure .....	10
PROGRAM TIMER operation procedure .....	11
HIGH POWER/ECONOMY operation procedure .....	12
Concerning CLEAN operation .....	13
Emergency run operation.....	13
Power blackout auto restart function .....	13
Remote control handling procedure .....	14
When the operation fails with the remote control .....	14
Operating hints .....	14
Maintenance.....	15
Has the unit been installed correctly? .....	17
Troubleshooting .....	17
Please remember! .....	18
When to contact your distributor without delay .....	19
Self diagnosis function .....	19

---

# Safety precautions

- Before starting to use the system, please read these "Safety precautions" carefully to ensure proper operation of the system.
- The safety precautions are classified as "⚠ DANGER" and "⚠ CAUTION". Precautions as shown in the column "⚠ DANGER" indicate that improper handling could have dramatic consequences like death, serious injury, etc. Nevertheless, even precautions as shown in the column "⚠ CAUTION" might pose a serious problem, depending on the circumstances. Please observe these precautions with great care, since they are essential to your safety.
- Symbols which appear frequently in the text have the following meaning:

	<b>Strictly prohibited</b>		<b>Observe instructions with great care</b>		<b>Provide positive earthing</b>
-----------------------------------------------------------------------------------	----------------------------	-----------------------------------------------------------------------------------	---------------------------------------------	-----------------------------------------------------------------------------------	----------------------------------

- When you have read the instruction manual, please keep it near at hand for consultation. If someone else takes over as operator, make certain that the manual is also passed on to the new operator.

## ■ INSTALLATION PRECAUTIONS

### ⚠ DANGER

**The system is meant for domestic, residential etc. use.**



If used in inferior environments, such as an engineering workplace, the equipment may function poorly.

**The system must be installed by your dealer or a qualified professional.**



It is not advisable to install the system yourself, as faulty handling may cause leakage of water, electric shock or fire.

### ⚠ CAUTION

**Do not install near places where inflammable gas may leak.**



Gas leaks may cause fire.

**Depending on the place of installation, a circuit breaker may be necessary.**



If you don't fit a circuit breaker, you may cause an electric shock.

**Make sure that you drain the hose properly, so that all the water has dripped out.**



Negligence may cause flooding in the room resulting in wet furniture.

**Make sure that the system has been properly earthed.**



Earth cables should never be connected to a gas pipe, municipal water pipe, lightning conductor or telephone earth cable. Incorrect installation of the earth cable may produce an electric shock.

## ■ OPERATION PRECAUTIONS

### ⚠ DANGER

**Do not expose yourself to the cooling air for prolonged periods.**



This could affect your physical condition and cause health problems.

**Do not insert anything into the air inlet.**



This may cause injury, as the internal fan rotates at high speed.

**Store the remote control out of reach of infants.**



Failure to observe this may result in the batteries being swallowed or other accidents.

### ⚠ CAUTION

**Only use approved fuses.**



Use of steel or copper wire instead of an approved fuse is strictly forbidden, as it may cause a breakdown or fire.

**Do not handle the switches with wet hands.**



This may cause an electric shock.

**Don't swing from the system.**



If the system falls down, you may get injured.

**Do not place a combustible insecticide or paint spray near the blower, nor aim it directly at the system.**



This may result in a fire.

**You should not expose any combustion appliance directly to the air stream of the air-conditioner.**



The appliance may then work inadequately.

**Do not wash the air-conditioner with water.**



This could cause an electric shock.

## Safety precautions

### ⚠ CAUTION

The system should only be used for its original purpose and not for anything else like, for instance, preservation of food, plants or animals, precision devices or works of art.



The system is only intended for use in ordinary domestic rooms. Any other use of the system may damage the quality of food, etc.

**Do not place anything containing water, like vases, on top of the unit.**



Water entering the unit could damage the insulation and therefore cause an electric shock.

**Do not install the system at a place where the air stream of the blower is aimed directly at plants or animals.**



This will damage their health.

**Do not sit on the outdoor unit nor put anything on it.**



If the unit falls down or things drop off it, people could get hurt.

**After a long period of use, check the unit's support structure from time to time.**



If you don't repair any damage straightaway, the unit may fall down and cause personal injury.

**Do not touch the aluminum fins on the air heat exchanger.**



Failure to observe this may result in injury.

**Do not place household electrical appliances or household items beneath the indoor or outdoor units.**



Condensation falling from the unit can stain objects and cause accidents or electrical shock.

**If you operate the system together with a combustion appliance, you must regularly ventilate the indoor air.**



Insufficient ventilation may cause accidents due to oxygen deficiency.

**Stand firmly on a stepladder or other stable object when removing the inlet panel and filters.**



Failure to observe this may result in injury through insecure objects toppling over.

**When you clean the system, stop the unit and turn off the power switch.**



Never clean the unit while the internal fan is rotating.

**Do not place objects near the outdoor unit or allow leaves to gather around the unit.**



If there are objects or leaves around the outdoor unit, small animals may enter unit and contact electrical parts resulting in break down, emission of smoke or flame.

**Contact your dealer to clean inside the indoor unit, do not attempt to do so yourself.**



The use of a non-approved detergent or improper washing method can damage the unit's plastic components and cause leaks. Damage, smoke, or fire can also result if the detergent comes in contact with electrical parts or the unit's motor.

**Stop the unit and turn off power if you hear thunder or there is a danger of lightning.**



Electrical storms can damage the unit.

## ■ PRECAUTIONS FOR TRANSFER OR REPAIRS

### ⚠ DANGER

**Consult your dealer for repairs to the system.**



Wrong repairs could cause an electric shock, fire, etc.

**If the air-conditioner is moved elsewhere, contact your dealer or a professional fitter.**



Faulty installation may cause water leakage, electric shock, fire, etc.

**If you notice anything abnormal (smell of burning, etc.), stop the system, turn off the power switch and consult your dealer.**



Continued use of the system in abnormal circumstances may result in malfunctioning, electric shock, fire, etc.

**If the air-conditioner fails to cool or warm, it may have a refrigerant leak. Contact your dealer.  
If refrigerant needs to be added, check with your dealer for proper instructions.**



The refrigerant used in your air-conditioner is safe. However, if refrigerant unexpectedly leaks from the unit onto a fan heater, stove, hotplate or other heat source, harmful products could be released.

# Name of each part and its function

## INDOOR UNIT

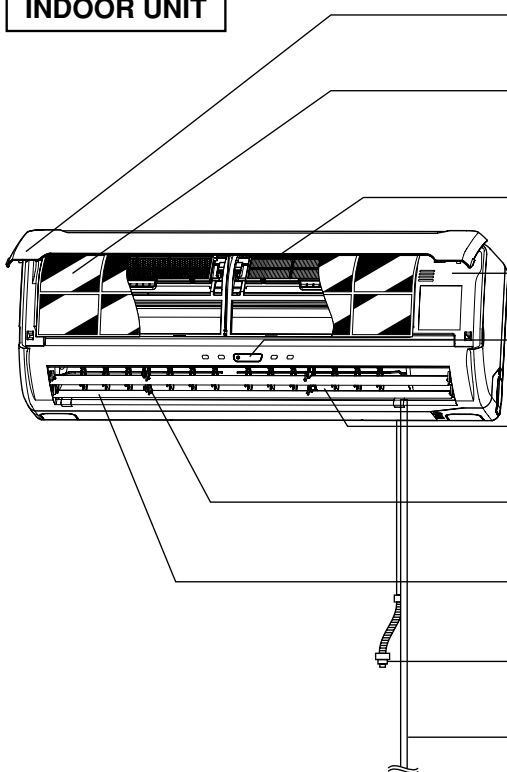

### Air Inlet panel

Draws in the indoor air.

### Air filter

Removes dust or dirt from the inlet air.

👉 Page 15

### Air-cleaning filter

### Room temperature detector

### Unit operation switch

### Air outlet

Air blows out of here.

### Left/right air flow adjustment louver

👉 Page 8

### Up/down air flow direction adjustment flap

👉 Page 8

### Drain hose

Drains water from the dehumidified air.

### Refrigerant piping connection electric flex

## Unit indication section

### TIMER light (yellow)

Illuminates during TIMER operation.

### RUN (HOT KEEP) light (green)

- Illuminates during operation and CLEAN operation.
- Blinks at air flow stop due to the 'HOT KEEP'.

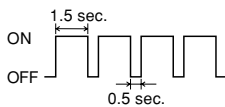

👉 Page 18

### HI POWER light (green)

Illuminates during HIGH POWER operation.

### ECONO light (orange)

Illuminates during ECONOMY operation.

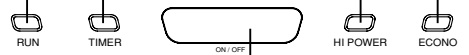

### Unit ON/OFF button

In emergencies, this button can be used for turning on/off the unit when remote control is not available. 👉 Page 13

### Remote control signal receiver

## OUTDOOR UNIT

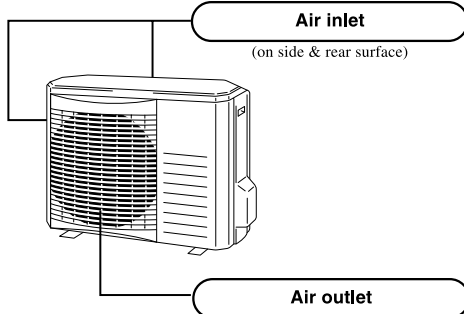

## Accessories

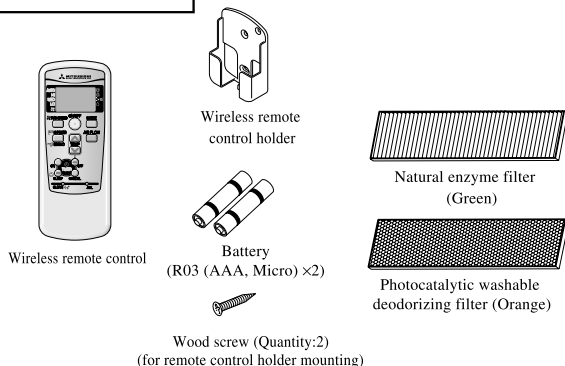

# Operation and indication section for remote control

## Operation section

### FAN SPEED button

Each time the button is pushed, the indicator is switched over in turn.

➔ Page 6

### HI POWER/ECONO button

This button changes the HIGH POWER/ECONOMY mode.

➔ Page 12

### TEMPERATURE button

This button sets the room temperature. (This button changes the present time and TIMER time.)

### ON TIMER button

This button selects ON TIMER operation.

➔ Page 10

### SLEEP button

This button selects to SLEEP operation.

➔ Page 9

### CLEAN switch

This switch changes the CLEAN mode.

➔ Page 13

### OPERATION MODE select button

Each time the button pushed, the indicator is switched over in turn.

➔ Page 6, 7

### ON/OFF (luminous) button

Press for starting operation, press again for stopping.

### AIR FLOW (UP/DOWN) button

This button changes the air flow (up/down) mode.

➔ Page 8

### OFF TIMER button

This button selects OFF TIMER operation.

➔ Page 9

### CANCEL button

This button cancels the ON timer, OFF timer, and SLEEP operation.

### RESET switch

Switch for resetting microcomputer and setting time.

➔ Page 14

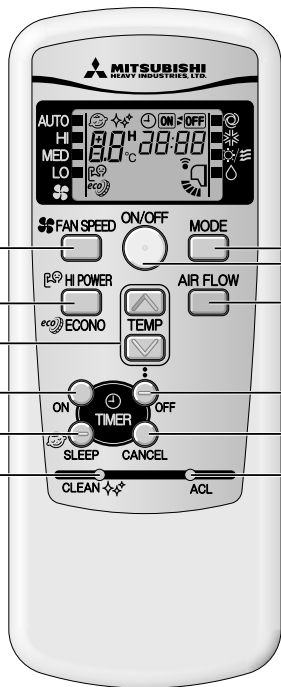

• The above illustration shows all controls, but in practice only the relevant parts are shown.

## Transmission procedure

When each button on the remote control is pressed – with the remote control pointing towards the air-conditioner unit a signal is transmitted. When the air-conditioner receives the signal correctly, it will beep.

## Present time setting procedure

■ When inserting the batteries, the present time is automatically set to time setting mode.

Example: Set to 10:30.

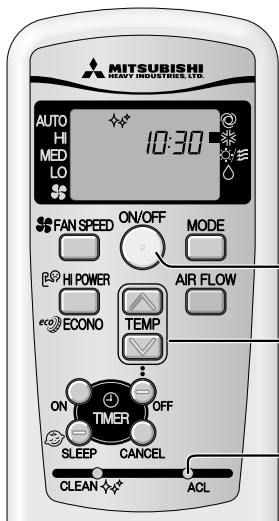

# 1

### Press the ACL switch.

Press with the tip of a ballpoint pen, etc. The time indicator blinks and can be set to the current time.

# 2

### Press the “ or ” button.

(Set to 10:30)

# 3

### Press the ON/OFF button.

The indication changes from blinking to steady lighting and the setting is complete.

Press within 60 sec.!

### NOTE

- The timer operation is set on the basis of the present time, so please set it correctly.
- The remote control data is reset when the present time is set.

# AUTO mode operation procedure

- Automatically selects the operation mode (COOL, HEAT, DRY) depending on the room temperature when switched on.

When the unit is not in AUTO mode:

**1** Press **MODE** button.

Move the [ ■ ] mark to the ☺ (Auto) position.

Aim the remote control at the air-conditioner.

**2** Press the **ON/OFF** button.

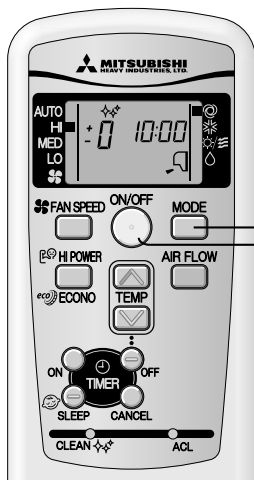

**To stop:** Press the **ON/OFF** button.

**NOTE**

- Air is not blowing out during the operation.

👉 Page 18

AUTO mode can be operated by simply pressing the ON/OFF button.

Air flow direction adjustment procedure. 👉 Page 8

- If you don't want the AUTO mode program, change to COOL, HEAT or DRY instead of AUTO. 👉 Page 7

# Temperature adjustment during AUTO

- Air temperature adjustment is possible even during automatic operation. There are 6 levels of adjustment possible with the ☺ button or the ☹ button. When a change in temperature is desired.

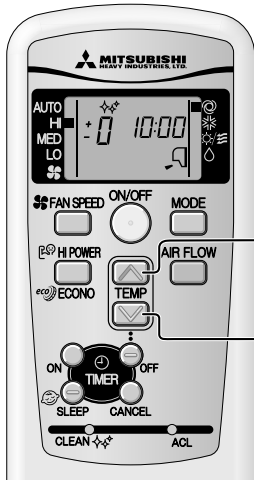

**1** Press the ☺ or ☹ button.

When it is a little cold  
Press the ☺ button.

- Each time the ☺ button is pressed, the switch over occurs in the following order -6 → -5 → ..... -1 → ±0 → +1 ..... +6. When +6 is indicated, even if the ☺ button is pressed, the indicator does not change.

When it is a little hot  
Press the ☹ button.

- Each time the ☹ button is pressed, the switch over occurs in the following order +6 → +5 → ..... +1 → ±0 → -1 ..... -6. When -6 is indicated, even if the ☹ button is pressed, the indicator does not change.

# About FAN SPEED

- You can choose the capacity of your air-conditioner when heating or cooling.

Operation capacity by your choice	FAN SPEED
Set automatically by microcomputer	AUTO
Powerful operation with high capacity	HI
Standard operation	MED
Energy-saving operation	LO

**Press the FAN SPEED button.**

Move the [ ■ ] mark to the desirable fan speed position.

→ AUTO → HI → MED → LO

# COOL/HEAT/DRY mode operation procedure

Aim the remote control at the air-conditioner.

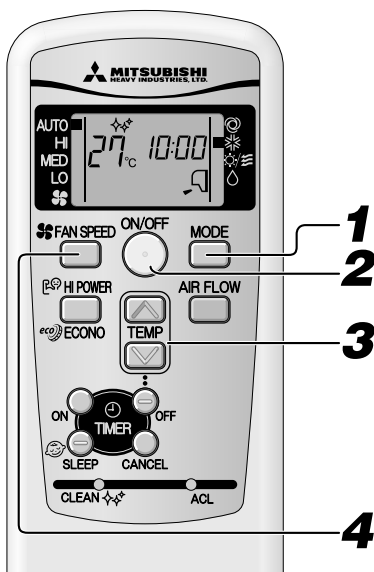

## 1

**Press the MODE select button.**

Move the [■] mark to the desirable operation position.

✱ (Cool), ☀ (Heat), △ (Dry)

## 2

**Press the ON/OFF button.**

## 3

**Press the TEMP button.**

Press ⊕ or ⊖ button for the desired temperature.

Standard

COOL	26°C~28°C	HEAT	22°C~24°C	DRY	21°C~24°C
------	-----------	------	-----------	-----	-----------

## 4

**Press the FAN SPEED button**

Set the fan speed as desired.

Air flow direction adjustment procedure. Page 8

### NOTE

- The air is not blown out during the operation. Page 18

**To stop:**

**Press the ON/OFF button.**

### Program changing procedure

Set the new program.

- The operation program can also be set or changed when the air-conditioner is not in operation.

## Air-conditioner operating conditions

- Use within the following operational range. Operating outside of this range may result in the protection devices being activated, preventing the unit from working.

	Cooling operation	Heating operation
Outside temperature	Approximately 21 to 43 °C	Approximately -5 to 21 °C
Inside temperature	Approximately 21 to 32 °C	Approximately 15 to 30 °C
Inside humidity	Below approximately 80% The long-term use of the unit with a humidity level exceeding 80% may result in condensation forming on the surface of the indoor unit, leading to water drips.	—

## Characteristics of HEAT mode operation

### Mechanism and capacity of HEAT mode operation

#### ■ Mechanism

- The unit draws in heat from the cold outside air, transfers it indoors and heats the room. The heating capacity of the heat pump mechanism decreases when the outside air temperature gets colder.
- The hot air circulation system takes a while before warming up the room temperature.
- If the outside temperature becomes extremely low, it would be better to use an additional source of heating.

### Defrosting

If the outside temperature becomes low and humidity is high, the heat exchanger in the outdoor unit may frost over, which prevents efficient heating.

**If this happens, the automatic defroster is activated and during defrosting the heating operation stops for 5 to 10 minutes.**

- Both indoor and outdoor fans stop and the RUN light (green) blinks slowly (1.5 sec. ON, 0.5 sec. OFF) during defrosting.
- The outdoor unit may give off some steam during defrosting. This is to help the defrosting process and is not a defect.
- The HEAT operation resumes as soon as defrosting has been completed.



# Air flow direction adjustment procedure

## Adjusting air flow direction

- Up/down direction can be adjusted with the AIRFLOW button on the remote control. Each time when you press this button the mode changes as follows:  
Change to AIRFLOW mode.

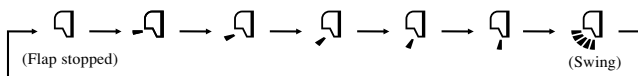

### NOTE

- When heating operation starts, the cold air outlet is blocked, so the flap move to the horizontal position, and resume the position that was set after the warm air output begins.
- When the compressor stops because the room temperature is higher than the temperature setting and it is in DEFROSTING operation, the flap will be in the horizontal position.
- The air flow direction cannot be set in the instances above. Change the air flow direction settings after the warm air starts flowing and it moves to the airflow direction that had been set.

## MEMORY FLAP (FLAP STOPPED)

When you press the AIRFLOW button once while the flap is operating, it stops swinging at an angle. Since this angle is memorized in the microcomputer, the flap will automatically be set at this angle when the next operation is started.

- Recommended angle of the flap when stopping

HEAT	 (Slant forward blowing)	COOL, DRY	 (Horizontal blowing)
------	-----------------------------	-----------	--------------------------

### ⚠ DANGER

- Avoid constant airflow to the body for hours on end.

### ⚠ CAUTION

- When in COOL or DRY operation, do not operate for hours on end with the air flow blowing straight down. Otherwise, condensation may appear on the outlet grill and drip down.
- Do not try to adjust the flaps by hand, as the control angle may change or the flap may not close properly.

## Adjusting left/right air flow direction

Adjust the direction by moving the left/right air flow fin by hand.

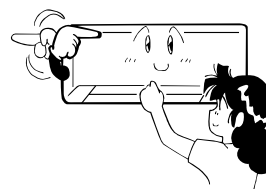

### ⚠ CAUTION

Please stop the air conditioner when adjusting the air flow direction.

# SLEEP operation procedure

- The unit stops automatically at the end of the set period of time. The room temperature is automatically controlled when the set time lapses, so that the room does not become too cold during cooling or too warm during heating.  Page 11

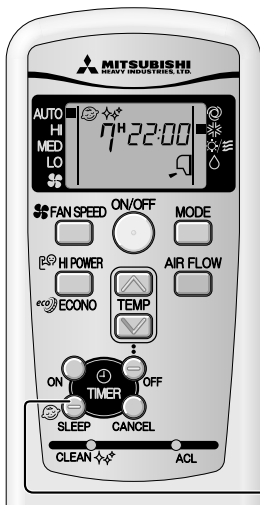

## 1 Press the SLEEP button.

- If this is pressed while the unit is off**  
SLEEP operation starts with the previous operation settings, and the air conditioning is turned off after the time that has been set passes.
- If this is pressed while the unit is running**  
Each time the button is pressed, the indication changes as follows:

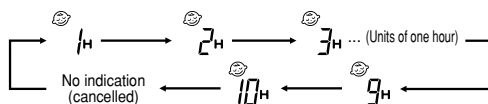

Example: You wish it to stop after 7 hours.

Set to 7H

The timer light (yellow) is on.

- The unit stops at the end of the set period of time.

### NOTE

- Cannot be set at the same time as OFF-TIMER.

#### Changing of set time

Set to a new time by using SLEEP button.

#### Releasing procedure

Press the CANCEL button to turn off the SLEEP indicator.

# OFF-TIMER operation procedure

- The unit stops automatically at the end of the set period of time. If it is stopped, perform the operations starting with STEP 1 and if running start with STEP 2.  
Example: You wish it to stop 22:30.

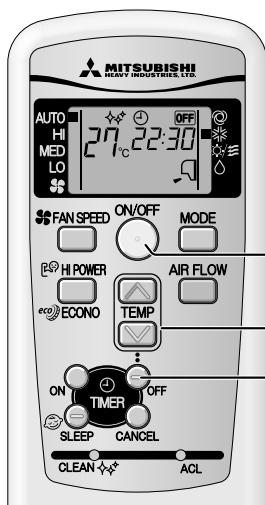

## 1 Press the ON/OFF button.

## 2 Press the OFF TIMER button.

OFF TIMER indicator OFF is blinking.

## 3 Press the “+ or -” button.

Each time the + button is pressed, the indicator is switched in the order of:

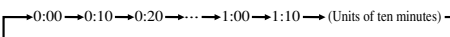

Each time the - button is pressed, the indicator is switched in the order of:

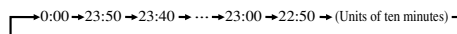

Set at 22:30.

## 4 Press the OFF TIMER button.

Press within 60 sec.!

The indication changes from blinking to steady lighting and the setting is complete. The timer light (yellow) is on.

- The unit stops at the end of the set period of time.

### NOTE

- The present time is not displayed during OFF-TIMER operation.
- Unlike SLEEP operation, automatic temperature adjustment is impossible during OFF-TIMER operation.

#### Changing of set time

Set a new time by using the OFF TIMER button.

#### Releasing procedure

Press the CANCEL button to turn off the timer indicator.

# ON-TIMER operation procedure

- Operation starts 5 to 60 minutes before the time that is set so that the room temperature reaches the optimum temperature at that time.  Page 11  
ON-TIMER operation can be set regardless of whether the air-conditioner is running or not.

Example: In the case you wish to bring the temperature to nearly set temperature in at 8:00.

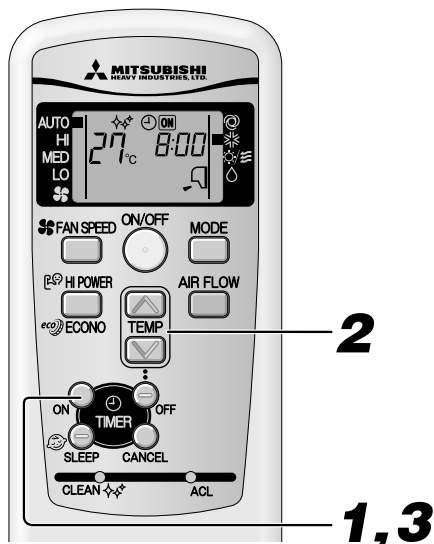

## 1 Press the ON-TIMER button.

ON TIMER indicator  is blinking.

## 2 Press the “ or ” button.

Each time the  button is pressed, the indicator is switched in the order of:

→0:00 →0:10 →0:20 →... →1:00 →1:10 → (Units of ten minutes)

Each time the  button is pressed, the indicator is switched in the order of:

→0:00 →23:50 →23:40 →... →23:00 →22:50 → (Units of ten minutes)

Set at 8:00.

## 3 Press the ON TIMER button.

Press within  
60 sec.!

The indication changes from blinking to steady lighting and the setting is complete. The timer light (yellow) is on.



- Operation starts 5 to 60 minutes before the set time.
- The TIMER light goes out at the set time.

### Changing of set time

Set a new time by using the ON-TIMER button.

### Releasing procedure

Press the CANCEL button to turn off the timer indicator.

### NOTE

- The present time is not displayed during ON-TIMER operation.

# SLEEP operation + ON-TIMER operation procedure

- Combined timer operation of SLEEP operation and ON TIMER.

Example: When it is desired to stop after 3 hours and then start operation at 8:00, near the set temperature.

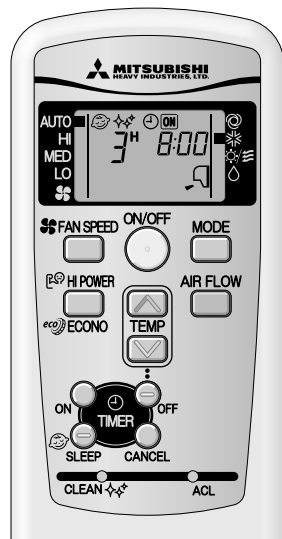

### SLEEP operation setting

Set by the procedures on page 9.

Set to 

### ON TIMER operation setting

Set by the above mentioned ON TIMER operation procedure.

Set to 

The setting of the lighting of the timer light (yellow) of this unit is complete.



- After the SLEEP operation set time has elapsed, the operation stops, and it starts from 5 to 60 minutes before the ON TIMER's time.
- The timer light is not lit at the ON TIMER's time.

### Changing of set time

Set a new time by using the SLEEP or ON TIMER button.

### Releasing procedure

Press the CANCEL button to turn off the timer indicator.

# PROGRAM TIMER operation procedure

- The timer operations that consist of the combination of the timer being set at both on and off. Once this has been set and operations started, operations will commence and end at the same time every day as long as the ON/OFF button is not pressed.



Example: When it is desired to stop at 22:30, and then start operation at 8:00, near the set temperature.

## OFF TIMER operation setting

Set by the procedures on page 9. Set to 

## ON TIMER operation setting

Set by the procedures on page 10. Set to 

The setting of the lighting of the timer light (yellow) of this unit is complete.

The time will be displayed on the remote control unit. The display will change depending on the operational status.



## Changing of set time

Set a new time by using the OFF TIMER or ON TIMER button.

## Releasing procedure

Press the CANCEL button to turn off the timer indicator.

## About Amenity facilities

Amenity facilities enable to start the operation a little earlier, so that the room should approach optimum temperature at ON time when the operation is started by ON-TIMER.

- Mechanism

The room temperature is checked 60 minutes before the timer is at ON. Depending on the temperature at that time, the operation starts 5 to 60 minutes before the timer is at ON.

- The Amenity facility only functions for COOL and HEAT operation mode (including AUTO). It does not work for DRY mode.

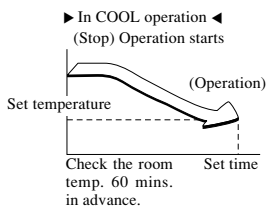

## About SLEEP operation

When SLEEP operation is selected, the room temperature is automatically controlled after a while, ensuring that the room is not too cold during cooling or too warm during heating.

- During cooling : the preset temperature is lowered by 1°C at the start of SLEEP operation (when the timer is set). After that, the temperature goes up by 1°C every an hour to become 2°C higher.
- During heating: Preset temperature is lowered by 1°C at the start of SLEEP operation (when the timer is set). After that the temperature is lowered by 1°C every 30 minutes to become 3°C lower in an hour and 6°C lower in two hours.

# HIGH POWER/ECONOMY operation procedure

If the air-conditioner is not operating, aim the remote control at the air-conditioner.

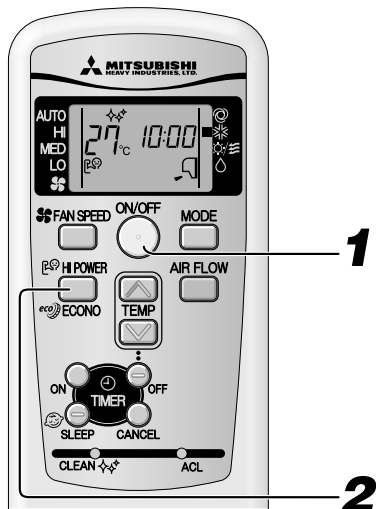

## 1

Press the ON/OFF button.

## 2

Press the HI POWER/ECONO button.

- When the operating mode is AUTO, COOL or HEAT  
Each time the HI POWER/ECONO button is pressed, the indicator is switched in the order of:

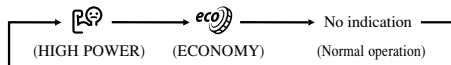

- When the operating mode is DRY or PROGRAM TIMER  
Each time the HI POWER/ECONO button is pressed, the indicator is switched in the order of:

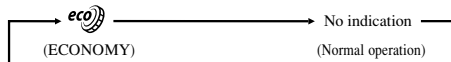

### Concerning HIGH POWER operation

Pressing the HI POWER/ECONO button intensifies the operating power and initiates powerful cooling or heating operation for 15 minutes continuously. The remote control indicates but the FAN SPEED indication is erased.

#### NOTE

- During the HIGH POWER operation, the room temperature is not controlled. When it causes an excessive cooling or heating, press the HI POWER/ECONO button once more to cancel the HIGH POWER operation.
- HIGH POWER operation is not available during the DRY and the program timer operations.
- During ON timer operation, HIGH POWER operation will start when the ON time is reached.
- When the following operations are conducted HIGH POWER operation will be canceled.
  - When the HI POWER/ECONO button is pressed again.
  - When the operation mode is changed.
  - When it has been 15 min. since HIGH POWER operation has started.

### Concerning ECONOMY operation

Pressing the HI POWER/ECONO button inflates a soft operation with the power suppressed in order to avoid an excessive cooling or heating. The unit operates 1.5°C higher than the setting temperature for weak wind capacity during cooling or 2.5°C lower than that during heating. The remote control indicates but the FAN SPEED indication is erased.

#### NOTE

- It will go into ECONOMY operation the next time the air-conditioner runs in the following instances.
  - When the air-conditioner is stopped using the ON/OFF button.
  - When the air-conditioner is stopped in SLEEP or OFF TIMER operation.
  - When CLEAN operation ends.
- When the following operations are conducted ECONOMY operation will be canceled.
  - When the HI POWER/ECONO button is pressed again.

# Concerning CLEAN operation

- CLEAN operation should be run after AUTO, COOL and DRY operation to remove the moisture from inside the indoor unit and control the growth of mold and bacteria.

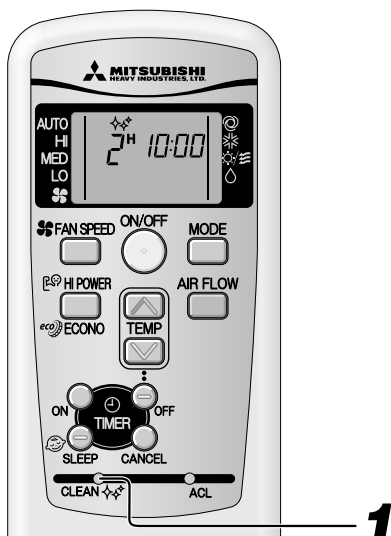

## 1 Press the CLEAN switch with the tip of a ballpoint pen.

Each time the CLEAN switch is pressed, the indicator is switched in the order of:

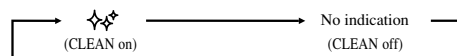

To stop: Press the ON/OFF button.

### NOTE

- CLEAN operation is impossible after HEAT, OFF-TIMER and SLEEP operations have stopped.
- The indoor unit fan runs for about two hours in CLEAN operation.
- The RUN light illuminates during CLEAN operation.
- Pressing the SLEEP button during CLEAN operation, cancels the CLEAN operation and the unit then sets itself to SLEEP operation.
- This is not a function for removing mold, germs or grime that have already adhered to the unit.

# Emergency run operation

- The unit ON/OFF button on the unit operates ON/OFF temporarily when the remote control is not used.

### Operation program

- OPERATION MODE : AUTO
- FAN SPEED : AUTO
- AIR FLOW : AUTO

- Operation starts by pressing the unit ON/OFF button; it stops if you press the button again.

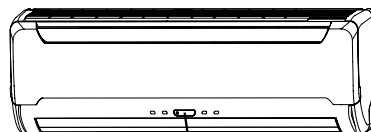

Unit ON/OFF button

### NOTE

- Do not hold the Unit ON/OFF button down for more than 5 seconds. (Holding it down longer than 5 seconds sets the automatic cooling used during servicing or when moving the air-conditioner.)

# Power blackout auto restart function

## What is power blackout auto restart function?

- Power blackout auto restart function is a function that records the operational status of the air-conditioner immediately prior to it being switched off by a power cut, and then automatically resumes operations at that point after the power has been restored.
- The following settings will be cancelled:
  - Timer settings
  - HIGH POWER operations

### NOTE

- The power blackout auto restart function is set at on when the air-conditioner is shipped from the factory. Consult with your dealer if this function needs to be switched off.
- When power failure occurs, the timer setting is cancelled. Once power is resumed, reset the timer.

# Remote control handling procedure

## Replacing the batteries

The following cases signify exhausted batteries. Replace old batteries with new ones.

- Receiving beep is not emitted when a signal is transmitted.
- Indicator fades away.

**1** Remove back lid and take out old batteries.

**2** Insert new batteries. R03 (AAA, Micro) x2

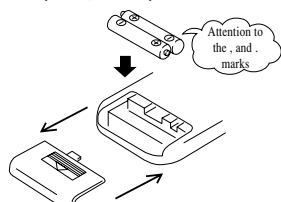

**3** Close back lid.

**4** Press the reset switch with the tip of a ballpoint pen.

The timer setting mode is indicated.



Page 5

### NOTE

- Don't use old and new batteries together.
- Remove the batteries when the remote control is not used for a long period.
- The life of a battery conforming to JIS or IEC should be 6 to 12 months with normal use. If used longer, or when an unspecified battery is used, liquid may leak from the battery, causing the remote control to malfunction.
- On the battery is printed its expected life. This may be shorter than that of the air-conditioner, depending on the date of manufacture. However, the battery may still be in working order after expiry of its nominal life.

- When the indicator shows any abnormal condition, Press the reset switch with the tip of a ballpoint pen.

## Using the remote control holder

The remote control can be attached to a wall or pillar by using a remote control holder. Before installing the remote control, check that the air-conditioner receives the signals properly.

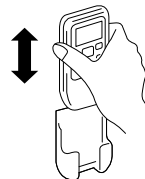

For installing or removing the remote control, move it up or down in the holder.

## Warning note for remote control handling

### Strictly prohibited

- |                                                                                                                                  |                                                                                                                                         |                                                                                                                      |
|----------------------------------------------------------------------------------------------------------------------------------|-----------------------------------------------------------------------------------------------------------------------------------------|----------------------------------------------------------------------------------------------------------------------|
| <ul style="list-style-type: none"> <li>• Don't go near high temperature places, such as an electric carpet or stove.</li> </ul>  | <ul style="list-style-type: none"> <li>• Don't leave the remote control exposed to direct sunlight or other strong lighting.</li> </ul> | <ul style="list-style-type: none"> <li>• Don't drop the remote control. Handle with care.</li> </ul>                 |
| <ul style="list-style-type: none"> <li>• Don't put any obstructing obstacles between the remote control and the unit.</li> </ul> | <ul style="list-style-type: none"> <li>• Don't spill water etc on the remote control.</li> </ul>                                        | <ul style="list-style-type: none"> <li>• Do not place heavy objects on the remote control, or step on it.</li> </ul> |

## When the operation fails with the remote control

- |                                                                                                                                                                                                                   |                                                                                                                                                                        |                |
|-------------------------------------------------------------------------------------------------------------------------------------------------------------------------------------------------------------------|------------------------------------------------------------------------------------------------------------------------------------------------------------------------|----------------|
| <ul style="list-style-type: none"> <li>• Are the batteries running down?<br/>  "Replacing the batteries" above.<br/>                     Replace the batteries with new ones and repeat the operation.</li> </ul> | <ul style="list-style-type: none"> <li>• If the operation still fails, handle as per emergency run operation.<br/>                     Contact your dealer.</li> </ul> | <p>Page 13</p> |
|-------------------------------------------------------------------------------------------------------------------------------------------------------------------------------------------------------------------|------------------------------------------------------------------------------------------------------------------------------------------------------------------------|----------------|

## Operating hints

- Please observe the following for the most economic and comfortable use of your unit.

<p><b>Set a suitable room temperature.</b></p> <p>Excessively high or low temperatures are not good for your health and waste electricity.</p>	<p><b>Clean the filters frequently.</b></p> <p>Clogged filters may block the air flow and cause less efficient operation.</p>	<p><b>Avoid direct sunlight and draught.</b></p> <p>Cut out direct sunlight by drawing the curtains or blinds when cooling. Keep windows and doors shut, except when ventilating.</p>
<p><b>Adjust the airflow direction properly.</b></p> <p>Adjust the up/down and left/right airflow to ensure a steady room temperature.</p>	<p><b>Operate the unit only when needed.</b></p> <p>Use the timer properly to operate the unit only when needed.</p>	<p><b>Generate little heat when cooling.</b></p> <p>Keep heat sources out of the room as much as possible.</p>

# Maintenance

## Before maintenance

Turn off the power switch.



• Don't spill water.



There's a danger of electric shock.

Wipe the unit with a soft, dry cloth.

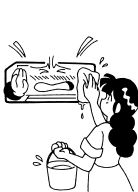

- Do not touch the aluminum fins on the heat exchanger.
- Stand firmly on a stepladder or other stable object when removing the inlet panel and filter.

Don't use the following articles:

- Hot water (40°C or more)  
It may deform or discolour the unit.
- Petrol, paint thinner, benzine or polishing agents, etc.  
They may deform or scratch the unit.

## During the operational season

Cleaning the air filter

Standard interval is once every two week

### 1 Remove the air filter

- ① Pull up to this side the air inlet panel.
- ② Lightly hold the knobs at both sides and lift a little to remove the panel to this side.

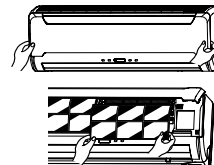

### 2 Cleaning

If the filter is very dirty, clean it with warm water (approx. 30°C), and dry it thoroughly.

- CAUTION**
- Don't clean the filters with boiling water.
  - Don't dry them over an open flame.
  - Pull them out gently.



### 3 Reinstall the air filter

- Holding firmly the filter at both sides as shown at right and insert securely.
- Operating without putting back the air filters will make the unit dusty, and may cause damage.

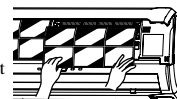

Cleaning the unit

- Wipe the unit with a soft, dry cloth, or use a vacuum cleaner.
- If the unit is very dirty, wipe it with a cloth soaked in warm water.

Cleaning the air inlet panel

- Removal, installation of air inlet panel .
- The panel can be washed with water. After washing with water, wipe any moisture off the panel and dry out of direct sunlight.

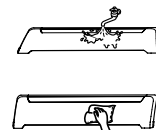

## How to open the air inlet panel

Place fingers at the recesses on both sides of the panel and pull up the panel to this side so that it will be opened by about 60 degrees.

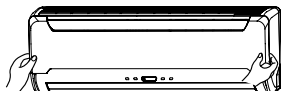

## How to close the air inlet panel

Push both sides evenly and press further lightly at the center.

## Removal, installation of air inlet panel

When removing the air inlet panel for internal cleaning or others, open the panel by 80 degrees and then pull it to this side.

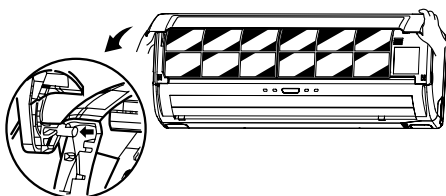

Secure the upper edge of the air inlet panel by lightly pushing it in, and then close the panel.

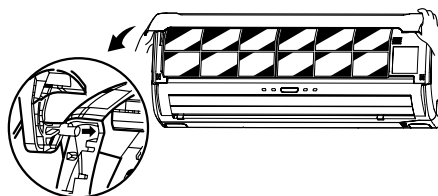



**NOTE**

Cooling/heating is affected by an air filter clogged up with dust etc., and the operation noise becomes louder. It may also use extra electricity. Please clean the air filter at appropriate intervals.

**At the end of the season**

- 1** Set the temperature setting for approximately a half day at 30°C and perform the cooling operation.

Dry the inside of the unit.

- 2** Stop the unit and turn off the power switch.

The unit uses appr. 2W even when the power switch has been turned off during the off-season for safety or for saving energy.

- 3** Clean and reinstall the air filters.

- 4** Clean both the indoor and outdoor units.

- 5** Remove batteries from the remote control.

**At the beginning of the season**

- 1** Make certain that there are no obstacles blocking the air flow around the air intake and outlet openings of the indoor and outdoor units.

- 2** Check the installation base for corrosion or rust.

- 3** Ensure that nothing has snapped and that the earthed flex is not disconnected.

- 4** Ensure that the air filters are clean.

- 5** Turn on the power switch.

- 6** Insert batteries in the remote control.

**Installing, inspecting, and replacing the air-cleaning filter**

1. Open the air inlet panel and remove the air filters.
2. Remove the filter holders, with the air-cleaning filter installed in the folders, from the air-conditioner.
3. Remove the photocatalytic washable deodorizing filter from the filter holder and inspect the filter. Periodically, remove any dust or dirt from the photocatalytic washable deodorizing filter. If the photocatalytic washable deodorizing filter is particularly dirt, it may be washed with water. However, the filter is fragile so be sure to wash it installed in the filter holder to avoid damaging it. After washing the filter, place it in sunlight to dry. Placing the filter in sunlight revitalizes the deodorizing effect.

Remove the natural enzyme filter from the filter holder and inspect the filters. Use a vacuum cleaner to remove any dust or dirt from the natural enzyme filters. Replace the natural enzyme filters if it cannot be cleaned or if it has been used for about 1 year. (The natural enzyme filter should be replaced after about 1 year of use. However, the actual replacement period may vary depending on the conditions in which the filters is used.)

(Do not dispose of the filter holders. They are reused.)

4. Install the air-cleaning filter in the filter holders, and then install the filter holders in the air-conditioner.

**NOTE**

The natural enzyme filter and the photocatalytic washable deodorizing filter may be installed on either the right or left side of the air conditioner.

5. Install the air filters and closed the air inlet panel.

**CAUTION**

Do not expose natural enzyme filters to direct sunlight for an extendet period. The bacteriolytic effect will be lost.

For replacement the air-cleaning filter, contact your dealer.

Item	Feature	Color
Photocatalytic washable deodorizing filter	Sources of odors on the filter are broken up, resulting in a deodorizing effect.	Orange
Natural enzyme filter	By using the work of enzyme, mold and bacteria on the filter are destroyed and the room air is kept clean.	Green

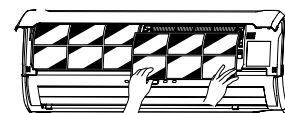
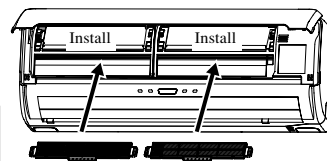
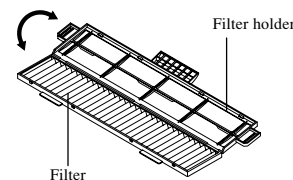
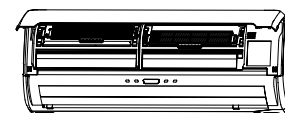
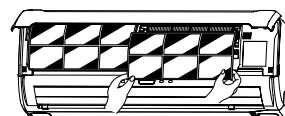

# Has the unit been installed correctly?

## Suitable installation position

- Is there any obstruction in front of the indoor unit, preventing proper ventilation and functioning?
- Don't install the unit in any of the following places:
  - Where there is a danger of leaking inflammable gases.
  - Where there is substantial splashing of oil.
- Malfunctioning due to corrosion may occur if the unit is installed in a spa where sulfide gases are generated, or in a seaside resort exposed to sea breezes. Contact your dealer.
- The air-conditioner and remote control must be at least 1 metre away from a TV set or radio.
- Drain the dehumidified liquid from the indoor unit into a spot that drains well.

## Pay attention to operating noises!

- When you install the unit, take care to choose a place that can comfortably stand the weight of the unit and does not increase the operating noise or vibration. If there is any likelihood that vibration may be transmitted through the house, fix the unit with the aid of vibration-proof pads between the unit and the fittings.
- Select a place where cold or hot air and operation noises from the indoor and outdoor units do not cause any inconvenience to your neighbours.
- Do not leave any obstacles near the outlet and inlet of the outdoor unit. This may cause malfunctioning and increased operating noise.
- If you hear an irregular noise during operation, contact your dealer.

## Inspection and maintenance

Dependent upon service conditions and operating environment, the inside of the air-conditioner may become dirty after a number of seasons' service (3 to 5 years). This will reduce performance. In addition to normal cleaning, we would recommend inspection and maintenance. (The air-conditioner has a longer life without any trouble.)

- Contact your dealer, or any distributor, for inspection and maintenance. (There will be a charge for this service).
- We would recommend inspection and maintenance to be carried out during the off-season.
- If the supply cord of this appliance is damaged, it must only be replaced by a repair shop appointed by the manufacturer, because special purpose tools are required.

# Troubleshooting

Please carry out the following checks before making a service call.

## The air-conditioner does not work at all.

Has the power switch been turned off?



Has the timer been set in the "ON" position?



Is there a power failure or a blown fuse?



If the air-conditioner does not operate properly after you have checked the left points, or if any doubt still exists after you have consulted page 18, or if things happen as shown on page 19, switch off the power and contact your dealer.

## Poor cooling or heating

Have you set the thermostat at a suitable temperature?

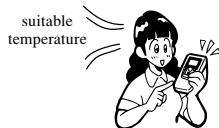

Is the air filter clean? (Not clogged?)



Did you leave any doors or windows open?

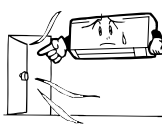

## Poor cooling

Is there any direct sunlight entering the room?



Is there a heat source in the room?





Are there too many people in the room?



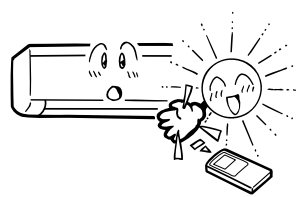

An alternative refrigerant (R410A) is used in this air-conditioner. When asking the dealer for service or inspection and maintenance, explain the dealer about this matter.

# Please remember!

<p><b>You cannot restart the unit immediately after you have stopped it.</b></p> <p>(RUN light is on)</p> <p>Not operating?</p> 	<p>Restarting has been blocked for 3 minutes after you have stopped or after switching off the power during operation, to protect the unit.</p> <p>Please wait for three minutes.</p>  <p>The three-minute protection timer in the microcomputer automatically starts up again.</p>
<p><b>Air is not blown out when starting the HEATING operation.</b></p> <p>RUN light blinks slowly (1.5 sec ON, 0.5 sec OFF)</p>	<p>Air flow has stopped to prevent blowing out of cold air until the indoor heat exchanger has warmed up. (2 to 5 min.) (HOT KEEP)</p>
<p><b>Air is not blown out for 5 to 10 min. or blown out not warm wind for a moment at HEATING operation.</b></p> <p>RUN light blinks slowly (1.5 sec ON, 0.5 sec OFF)</p>	<p>When outdoor temperature is low and humidity is high, the unit sometimes performs defrosting automatically. Please wait. During defrosting, water or steam may escape from the outdoor unit.</p>
<p><b>Air is not blown out when starting the DRY operation.</b></p> <p>(RUN light is on)</p>	<p>The indoor fan may stop to prevent re-evaporation of dehumidified moisture and to save energy.</p>
<p><b>Some steam escapes during COOL operation.</b></p>	<p>This may occur if the room's temperature and humidity are very high. It disappears as soon as the temperature and humidity decrease.</p>
<p><b>There is a slight smell.</b></p>	<p>Air blown out during operation may smell. This is caused by tobacco or cosmetics sticking to the unit.</p>
<p><b>You hear a slight gurgling sound.</b></p> 	<p>This is caused by liquid refrigerant moving within the piping of indoor unit. Liquid refrigerant will be evaporated and become as gaseous refrigerant during passing through the pipe in order to absorb the heat inside the room.</p>
<p><b>You hear a slight cracking sound.</b></p>	<p>This is caused by expansion and contraction of plastic body. Temperature change of plastic material due to compressor's alternative operation cause a slight cracking noise.</p>
<p><b>You hear a hissing or clicking sound.</b></p>	<p>This is caused by the operation of the refrigerant control valves or electric components.</p>
<p><b>After a power cut, you cannot re-start, even if power has been restored, unless you have the power blackout auto restart function.</b></p>	<p>The memory circuit of the microcomputer has been wiped out. Use the remote control to start the operation again.</p>
<p><b>Remote control signals are not received.</b></p>	<p>Remote control signals may not be received if the signal receiver on the air-conditioner is exposed to direct sunlight or other bright light. If so, cut out the sunlight or reduce the other light.</p> 
<p><b>Moisture may form on the air outlet grills.</b></p>	<p>If the unit is operated for a long time in high humidity, moisture may form on the air outlet grills and start dripping.</p>
<p><b>Fan won't stop immediately after unit operation was stopped.</b></p>	<p>Indoor fan : Fan will not stop after 2 hours if set to CLEAN operation.</p>
<p><b>RUN light stays on even though operation was stopped.</b></p>	<p>The RUN light illuminates during CLEAN operation. Run light turns off when CLEAN operation ends.</p>

# When to contact your distributor without delay

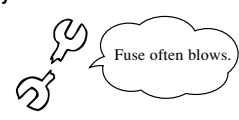
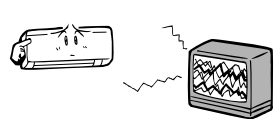
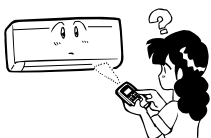
■ Turn off the power switch immediately and inform your dealer in any of the following situations:

<p><b>The fuse or switch blows continuously.</b></p> 	<p><b>The cable becomes extremely hot. The covering of the cable is cracked.</b></p> <p style="text-align: center;">⚠ CAUTION</p> <p>If the power cord becomes damaged, ask your dealer or a qualified engineer to install the replacement to avoid accidents.</p>	
<p><b>The TV, radio or other equipment starts to malfunction.</b></p> 	<p><b>A switch does not activate properly.</b></p> 	<p><b>You hear a strange noise during operation.</b></p> 
<p><b>When faulty movement is observed when the ON/OFF button is pressed, even after turning off the power switch and restarting the operation after 3 minutes, the faulty movement does not disappear.</b></p> 		<p><b>The RUN and TIMER lights on the unit indication section blink quickly (0.5 sec. ON; 0.5 sec. OFF) and don't work.</b></p>

## Self diagnosis function

■ We are constantly trying to do better service to our customers by installing such judges that show abnormality of each function as follows:

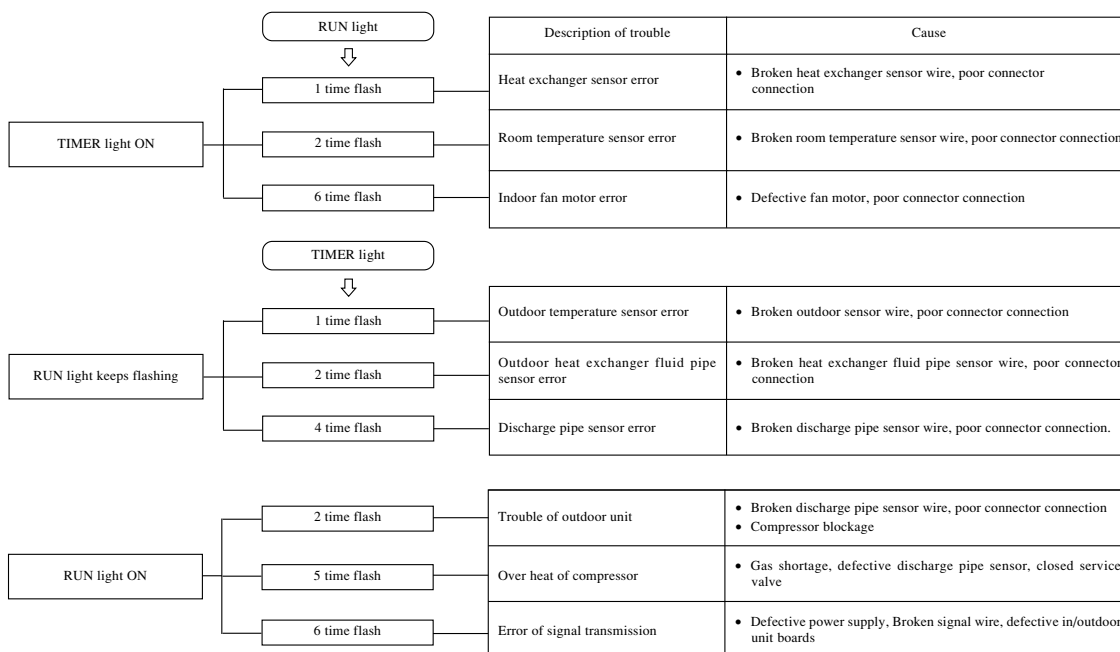





---

## **AIR-CONDITIONING & REFRIGERATION SYSTEMS HEADQUARTERS**

16-5, 2-Chome, Kounan, Minato-ku, Tokyo, 108-8215, Japan  
Fax: (03) 6716-5926

## **MITSUBISHI HEAVY INDUSTRIES EUROPE, LTD.**

### **AIR-CONDITIONER DIVISION**

3rd Floor Thavies Inn House 3-4 Holborn Circus London EC1N 2HA, ENGLAND  
Phone: 44(0)20 7842 8171  
Fax: 44(0)20 7842 8104



**Большая библиотека технической документации**  
**<http://splitoff.ru/tehn-doc.html>**  
**каталоги, инструкции, сервисные мануалы, схемы.**